

AVIDITY™

SCIENCE

LABORATORY WATER PORTFOLIO

LABORATORY WATER WITH CONFIDENCE



Enabling scientific research with a clearer laboratory water solution.

At Avidity Science, we are as enthusiastic about designing the ultimate laboratory water systems, as you are about your research and results.

Developed with today's laboratory in mind and manufactured globally, our range combines space and cost saving initiatives with a stylish finish - the Avidity Science way.

As your dedicated laboratory water experts, we can offer advice and guidance from initial enquiry, layout and distribution designs through to complete project management and installation. Thereafter, you can rely on Avidity Science to maintain your pure water supply for years to come.



Certificate No: FS 558309



Introducing the Avidity Science difference. *Our strength is in supporting scientists.*

We understand the critical nature of pure water for research facilities like yours; enabling scientific breakthroughs to be achieved across the research sector. That's why our products and services are based on your requirements.

At Avidity Science, we offer a pure water solution for every laboratory application, supported by our experienced team of technicians who will ensure that your pure water supply is never compromised.

EXPERT

Many years of water purification and delivery methods to provide unparalleled solutions to the laboratory space.

SUPPORT

With a customer-centric culture and a focus on service excellence, we're there when and where you need us.

APPROACHABLE

We genuinely enjoy the customers we work with. When you have a shared passion, it's easy to work together for a joint goal.

Excellent service in all forms.

User guides, video tutorials, online assistance, helpdesk and local technicians.



Avidity Science Service, from the start

Avidity Science can provide specialist support from our experienced, global-based, project team who are equipped with the latest in design technology, to deliver the right configuration to your laboratory.

We will guide you through product selection and layout designs and our installation engineers will ensure minimal disruption to your work whilst we commission your new laboratory water systems.



Learn from our Global Experts

Operator training is free of charge on installation. We can supply customised advanced training on any of our products as required throughout your region.

A Service Plan to Suit Your Needs

Select the correct service plan for complete peace of mind adapted for you.

Your equipment will be well looked after by our own experts who are also able to service third party models.

Contact us today for your bespoke quote.

<p>Why Choose a Service Contract?</p>	<p>Reduce Risk Protect your equipment, your employees and your work</p>
	<p>Create Savings Regular maintenance reduces unexpected invoices for repairs</p>
	<p>Consistent Results Keep your machine and equipment working at optimum capacity</p>

With a customer-centric culture and a focus on service excellence, we're there when and where you need us.

Additional Services

Bespoke Water Systems for New Buildings and Laboratories

We provide many water purification options for laboratories in university and clinical research environments, healthcare, diagnostics and pharmaceutical settings.

Our on-site qualified design and projects team offer a full design and installation service for your water distribution needs. With extensive experience in supplying and installing systems, we will manage the project from the design stage through to completion of your new or refurbished laboratory or building.

Global Standards Established

Our portfolio is compliant to globally recognised, water purification quality standards for ultimate customer reassurance. Notably ISO 3696:1995, ASTM and CLRW (CLSI).



Ensuring precise purity for *your* applications

III	II	I
REVERSE OSMOSIS (RO)	DEIONISED (DI)	ULTRAPURE
<40µS/cm Up to 98% rejection of incoming feedwater inorganics, typically	1 - 15MΩ-cm	18.2MΩ-cm
APPLICATION		
<ul style="list-style-type: none"> Autoclave Feed Glasswasher Feed Feed to Ultrapure Water Systems Hydroponics Steam Generators 	<ul style="list-style-type: none"> Buffer & Media Preparation Sample Dilution & Reagent Preparation Spectrophotometry Protein Electrophoresis Cytology & Histology Glassware Washing & Rinsing 	<ul style="list-style-type: none"> Molecular Biology Electrochemistry Critical Cell & Tissue Culture (GF) AAS, HPLC, IC, ICPMS, GC, MS DNA Sequencing Genomics Proteomics Immunology Pharmacology
PROCESS		
Reverse Osmosis (RO) This is the most economical method of removing up to 98% of feed water inorganic contaminants and >99% of organics, bacteria and particulates. In water purification, external pressure is applied to the more concentrated side of the membrane to reverse the natural osmotic flow. This forces the feed water through the semi-permeable membrane to produce permeate. The impurities are deposited on the membrane surface and flushed to drain as concentrate.	Deionisation (DI) / Ion Exchange This process removes ions from water, usually RO water, with the use of synthetic cation and anion resins. The ions are removed from the water through a series of chemical reactions. These reactions occur as the water passes through the ion exchange resin beads. Gradually, all unwanted ions are exchanged for hydrogen and hydroxyl ions which combine to form pure water.	Ultraviolet (UV) Photo Oxidation at 254nm & 185nm Photochemical oxidation and UV light eliminate trace organics and inactive microorganisms in feed water. The 254nm light reacts with bacterial DNA resulting in denaturation. The 185nm light breaks down long chain organics which can then be removed from the water by ion exchange. Final Filtration Typically final filtration is deployed at the end of the process to ensure near total removal of such impurities. Depending on the type of filtration, pyrogens, nucleases and particle options are available.

Introducing the *i-Series* water purification range

The *i-Series* water purification range offers superior reverse osmosis purification with up to 99% ion rejection, using the unique twin pass RO technology to cope with the most challenging of feed waters.

Indisputable water quality

- Unique twin pass RO technology
- Specific Pre-treatment Module

Intelligent monitoring

- Data Capture
- System Monitoring

Information at a glance

- On-screen flow diagram
- Reservoir levels visible on multiple displays throughout

Integrity of data

- Cartridge traceability with data tag
- Printable option

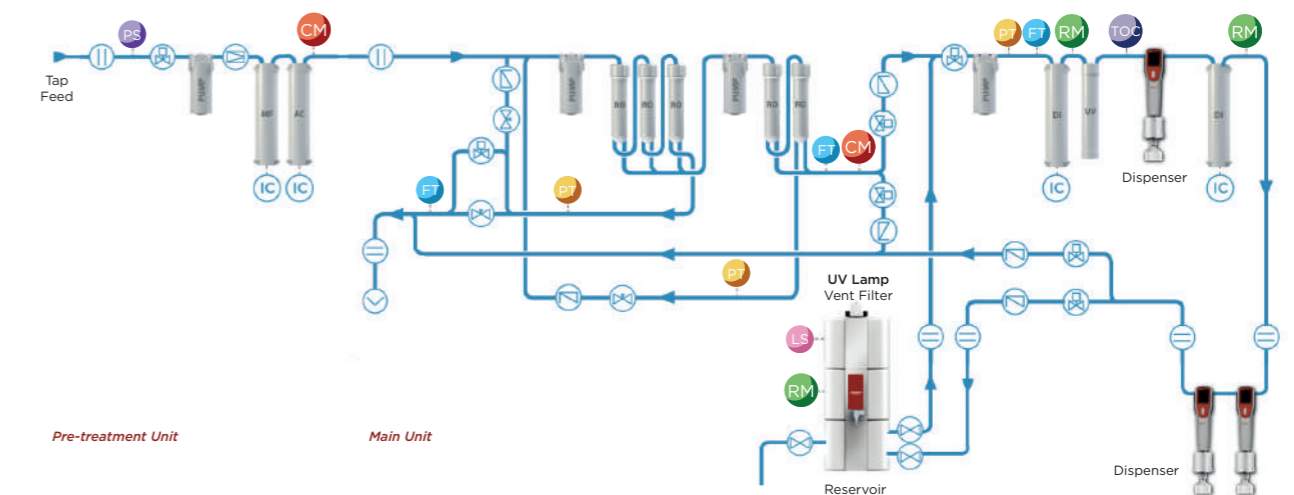

PS Pressure switch
FT Flow transmitter
RT Resistivity transmitter
TOC TOC indicator
SV Solenoid valve
IC Intelligent chip
DV Decompression valve
DR Drain

CT Conductivity transmitter
PT Pressure transmitter
LS Level sensor
HI Hand valve
CV Check valve
RV Restrictor valve
CO Connector

Duo-i III Flowchart

Avidity Science Laboratory Water Systems Overview

Let us help you find the perfect partner for your laboratory. Our portfolio encompasses systems that can provide Type 3 to Type 1 water, each with their own features. Use the helpful table below to narrow down the most suitable system for you based on your requirements.





MODEL	WATER QUALITY	PRODUCTION RATE (L/HR)	TOC MONITORING	RESERVOIR REQUIRED	FINAL FILTER OPTIONS	WALL MOUNTABLE	TOUCH SCREEN USER INTERFACE	REMOTE DISPENSER OPTION	DIMENSIONS (HXWxD)	DRY WEIGHT	KEY FEATURES	PAGE IN BROCHURE
Puro™ III	Type III	Up to 25, 45 or 85L/hr		✓		✓	✓		500 x 490 x 290mm	23kg	<ul style="list-style-type: none"> RO dampening technology Anti vibration Variable flow rates 	10
Puro™ III T	Type III	10 or 20L/hr				✓	✓		500 x 485 x 330mm	20kg	<ul style="list-style-type: none"> Compact Integrated tank 	11
Puro™-i III	Type III	5, 10, 20 or 30L/hr	✓*	✓			✓	✓	575 x 366 x 492mm	23kg	<ul style="list-style-type: none"> Twin pass RO Data capture Drop by drop dispensing Cartridge traceability 	12
Geno™ II	Type II	Up to 25 or 45L/hr		✓		✓	✓		500 x 490 x 290mm	23kg	<ul style="list-style-type: none"> RO dampening technology Anti vibration Variable flow rates 	13
Geno™ II T	Type II	10 or 20L/hr				✓	✓		500 x 485 x 330mm	20kg	<ul style="list-style-type: none"> Compact Integrated tank 	14
Duo™ III I	Type II & I	Up to 25L/hr	✓	✓	✓	✓	✓	✓	500 x 490 x 290mm	30kg	<ul style="list-style-type: none"> RO dampening technology Variable flow rates Drop by drop dispensing 	15
Duo™-i III I	Type III & I	5, 10, 20 or 30L/hr	✓*	✓	✓		✓	✓	575 x 366 x 492mm	23kg	<ul style="list-style-type: none"> Twin pass RO Data capture Drop by drop dispensing Cartridge traceability 	16
Duo™-i II I	Type II & I	5, 10, 20 or 30L/hr	✓*	✓	✓		✓	✓	575 x 366 x 492mm	23kg	<ul style="list-style-type: none"> Twin pass RO Data capture Drop by drop dispensing Cartridge traceability 	17
Alto™ I	Type I	Up to 2 L/min	✓		✓	✓	✓	✓	500 x 490 x 290mm	23kg	<ul style="list-style-type: none"> Anti vibration Automatic flush Cartridge traceability Drop by drop dispensing 	18
Alto™-i I	Type I	Up to 2 L/min	✓*		✓		✓	✓	575 x 366 x 492mm	23kg	<ul style="list-style-type: none"> Application specific cartridges Data capture Drop by drop dispensing Cartridge traceability 	19

* Optional regional differences

* Dimensions for all accessories can be found on pages 20-21

SECTOR KEY

Look for the icon that matches your needs to find products designed with you in mind.

-  Academia/Government
-  Applied
-  Industrial
-  Pharma/Biotech

Puro™ III

Pure water in high demand



Reverse Osmosis

- Up to 85L/hr with a compact footprint
- RO sanitisation process
- Quiet operation provided by unique dampening technology
- One easy-change pre-filter
- Mount on bench, wall or on top of a reservoir
- Intuitive, icon-based, interactive user interface with touchscreen
- Integrated leak detector and boost pump
- Choice of storage reservoir size

Puro™ III T

Small in size. Big in Benefits



Reverse Osmosis

- Space-saving footprint with integrated 35L reservoir
- Make-up rate 10 or 20L/hr with fast dispense
- Intuitive, icon-based, interactive user interface with touchscreen
- Wall or bench mounting
- Quiet, internal boost pump and patented anti-vibration mountings
- Energy consumption of <60w when processing water

MODEL	MAKE-UP FLOW RATE (@15°C)	WATER QUALITY	INORGANICS REJECTION RATE**	DAILY USAGE (MAX)	FEED WATER PRESSURE
PURO III 20	≥25L/hr	<40µS/cm	≥98%	160L/day	0.1 - 6 bar
PURO III 40	≥45L/hr	<40µS/cm	≥98%	320L/day	0.1 - 6 bar
PURO III 80	≥85L/hr	<40µS/cm	≥98%	640L/day	2 - 6 bar

MODEL	MAKE-UP FLOW RATE (@15°C)	WATER QUALITY	INORGANICS REJECTION RATE**	DAILY USAGE (MAX)*	FEED WATER PRESSURE
PURO III T 10	10L/hr	<40µS/cm	≥98%	100L/day	0.1 - 6 bar
PURO III T 20	20L/hr	<40µS/cm	≥98%	200L/day	0.1 - 6 bar

* Based on make-up rate of 10hr/day excluding DI resin capacity

** On UV model and depending on feedwater impurities

** Depending on feedwater impurities

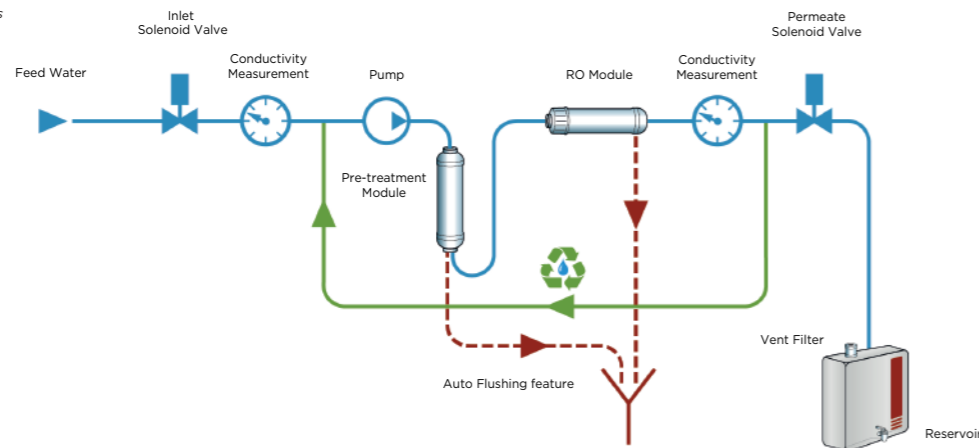

Want to view the system Specifications?



SCAN ME

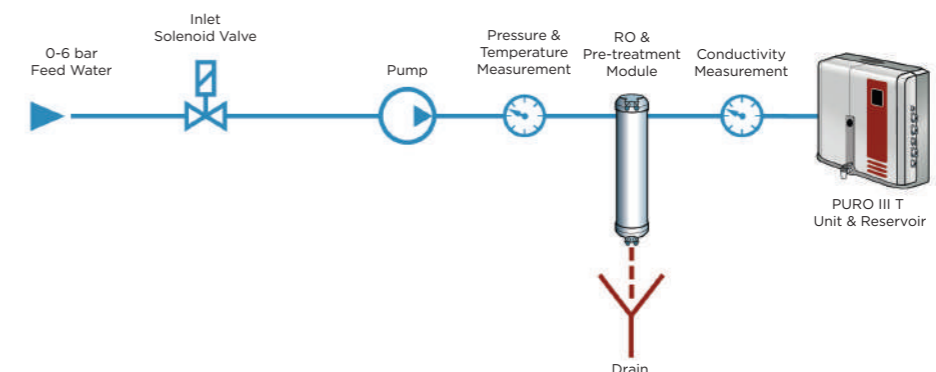

Want to view the system Specifications?



SCAN ME



Puro-i III

Confidence in quality



Reverse Osmosis

- Unique twin pass RO technology (<math><10\mu\text{S}/\text{cm}</math>, typical <math><5\mu\text{S}/\text{cm}</math> if feed condition is <math><2000\mu\text{S}/\text{cm}</math>)
- Auto RO sanitisation
- Interactive 7" touch screen
- Remote dispensing option for Type 3 water
- Auto reservoir sanitisation option
- Flexible pre-treatment options for variable feedwater quality

Geno II

Beyond expectation



Deionised Water

- Type 2 DI water
- RO sanitisation process
- Simple operation with easy-change consumables
- Mount on bench, wall or on top of a reservoir
- Intuitive, icon-based, interactive user interface with touchscreen
- Integrated leak detector and boost pump
- Choice of storage reservoir size

MODEL	MAKE-UP FLOW RATE (@15°C)	WATER QUALITY	DISPENSE FLOW RATE	INORGANICS REJECTION RATE	BACTERIA* (<math><0.01\text{CFU}/\text{mL}</math>)	PARTICLES (>0.2 μM)* (<math><1/\text{mL}</math>)	FEED WATER PRESSURE
PURO-i III 5	5L/hr	<math><40\mu\text{S}/\text{cm}</math>	≥2L/min	≥99%	<math><0.01\text{CFU}/\text{mL}</math>	<math><1/\text{mL}</math>	0.5 - 6 bar
PURO-i III 10	10L/hr	<math><40\mu\text{S}/\text{cm}</math>	≥2L/min	≥99%	<math><0.01\text{CFU}/\text{mL}</math>	<math><1/\text{mL}</math>	0.5 - 6 bar
PURO-i III 20	20L/hr	<math><40\mu\text{S}/\text{cm}</math>	≥2L/min	≥99%	<math><0.01\text{CFU}/\text{mL}</math>	<math><1/\text{mL}</math>	0.5 - 6 bar
PURO-i III 30	30L/hr	<math><40\mu\text{S}/\text{cm}</math>	≥2L/min	≥99%	<math><0.01\text{CFU}/\text{mL}</math>	<math><1/\text{mL}</math>	0.5 - 6 bar

* With LWFS32302 final filter

MODEL	MAKE-UP FLOW RATE (@15°C)	WATER QUALITY (@25°C)	DISPENSE RATE FROM TANK*	INORGANICS REJECTION RATE**	DAILY USAGE (MAX)	FEED WATER PRESSURE
GENO II 20	≥25L/hr	1 - 15MQ·cm	3 - 7L/min	≥98%	160L/day	0.1 - 6 bar
GENO II 40	≥45L/hr	1 - 15MQ·cm	3 - 7L/min	≥98%	320L/day	0.1 - 6 bar

* Depending on tank and pump setup

** Depending on feedwater impurities

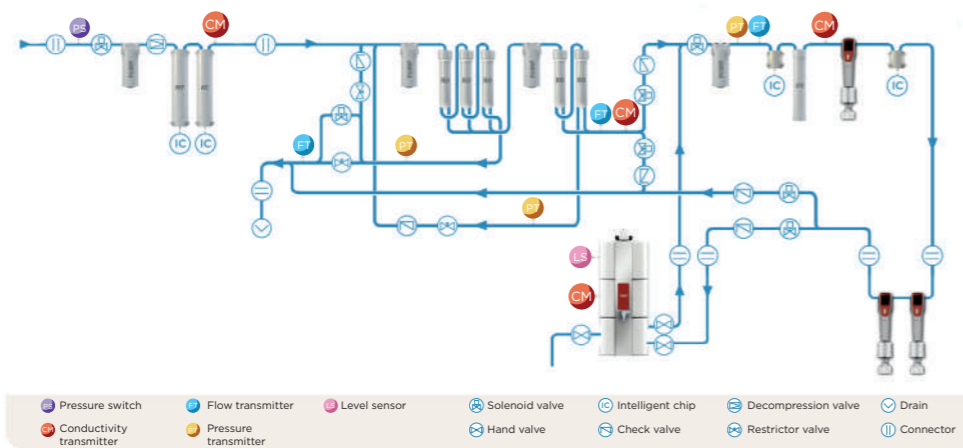

Want to view the system Specifications?



SCAN ME

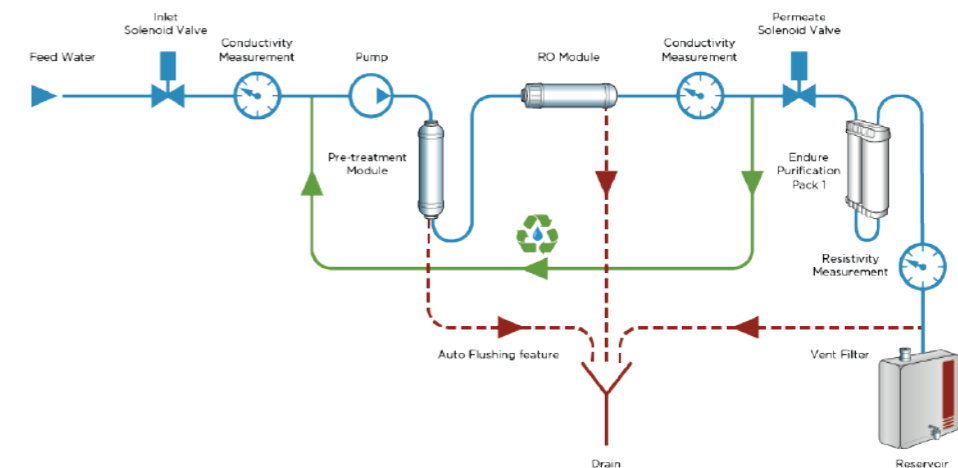

Want to view the system Specifications?



SCAN ME



Geno™ II T

For all sensitive laboratory applications



Deionised Water

- Type 2 (DI) water
- Space-saving footprint with integrated 35L reservoir
- Make-up rate 10 or 20L/hr with fast dispense
- Intuitive, icon-based, interactive user interface with touchscreen
- Wall or bench mounting
- Quiet, internal boost pump and patented anti-vibration mountings
- Energy consumption of <60w when processing water

Duo™ II I

Dual quality; One clear solution



Deionised and Ultrapure Water

- Type 2 and Type 1 water quality from one unit
- Option of integrated and remote dispensers (up to two)
- Intuitive, icon-based, interactive user interface with touchscreen
- Up to 2L/min Ultrapure Water with volumetric dispense
- Variable make up rate up to 25L/hr
- Mount on-bench, under-bench or on the wall
- Continuous TOC monitoring
- Low Endotoxin, RNase, DNase and Protease options available

MODEL	MAKE-UP FLOW RATE (@15°C)	WATER QUALITY (@25°C)	TOC REDUCTION***	INORGANICS REJECTION RATE**	DAILY USAGE (MAX)*	FEED WATER PRESSURE
GENO II T 10	10L/hr	1 - 15MΩ-cm	96%	≥98%	100L/day	0.1 - 6 bar
GENO II T 20	20L/hr	1 - 15MΩ-cm	96%	≥98%	200L/day	0.1 - 6 bar

* Based on make-up rate of 10hr/day excluding DI resin capacity
 ** On UV model and depending on feedwater impurities
 *** Depending on feed water quality

MODEL	MAKE-UP FLOW RATE (@15°C)	WATER QUALITY (@25°C)	DISPENSE FLOW RATE	DISPENSER WATER QUALITY (@25°C)	BACTERIA	TOC	ENDOTOXINS**	RNASE**	DNASE**	PROTEASE**
DUO II.I	≥25L/hr	15MΩ-cm	≥2L/min	18.2MΩ-cm	<0.01CFU/mL	≤5ppb	<0.001EU/mL	<1pg/mL	<5pg/mL	<0.15µg/mL
DUO II.I-R	≥25L/hr	15MΩ-cm	≥2L/min	18.2MΩ-cm	<0.01CFU/mL	≤5ppb	<0.001EU/mL	<1pg/mL	<5pg/mL	<0.15µg/mL

** Using correct final filter TC004

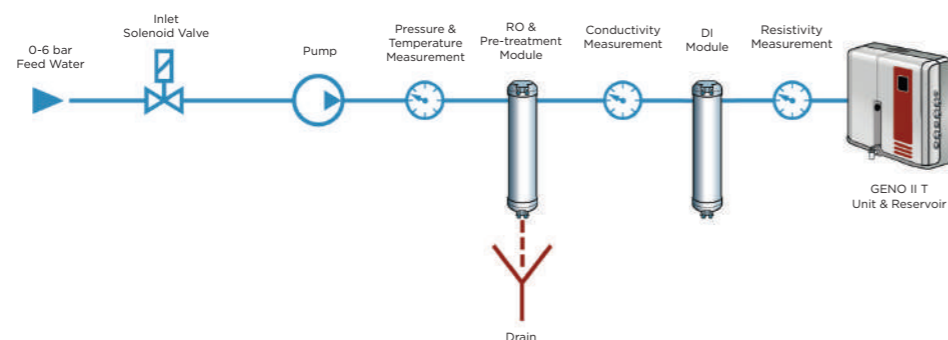

Want to view the system Specifications?



SCAN ME

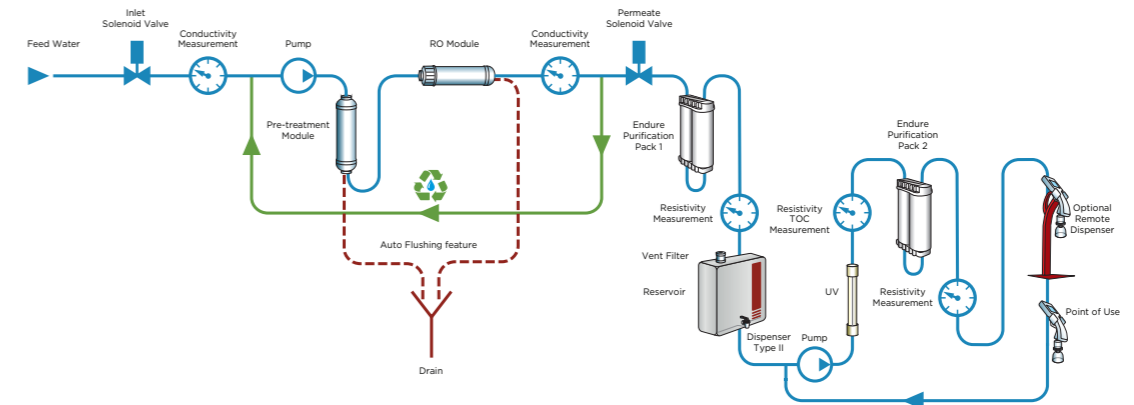

Want to view the system Specifications?



SCAN ME



DuoTM-i

Efficient
Dual Quality



Reverse Osmosis and Ultrapure Water

- Dispense Type 3 and Type 1 water from the remote dispensers
- Unique twin pass RO technology (<10µS/cm, typical <5µS/cm if feed condition is <2000µS/cm)
- Data capture with printable option
- Dispense Type 3 water from the reservoir
- Adjustable dispenser
- Cartridge traceability with data tag
- Auto Reservoir sanitisation option
- Interactive 7" touch screen
- Colour coded dispensing stations with flexible dispensing options

DuoTM-i

Intelligent
Dual Quality



Deionised and Ultrapure Water

- Dispense Type 2 and Type 1 water from the remote dispensers
- Unique twin pass RO technology ensures enhanced DI cartridge capacity
- Data capture with printable option
- Specific cartridges for your critical applications
- Integrated Water Leakage Protection
- Adjustable dispenser
- Cartridge traceability with data tag
- Interactive 7" touch screen
- Colour coded dispensing stations with flexible dispensing options

MODEL	MAKE-UP FLOW RATE (@15°C)	WATER QUALITY (@25°C)	DISPENSE FLOW RATE	BACTERIA*	TOC****	ENDOTOXINS**	RNASE***	DNASE***	PROTEASE***
TYPE 3									
DUO-i III 5	5L/hr	<5µS/cm	≥2L/min	<0.01CFU/mL	<30ppb	-	-	-	-
DUO-i III 10	10L/hr	<5µS/cm	≥2L/min	<0.01CFU/mL	<30ppb	-	-	-	-
DUO-i III 20	20L/hr	<5µS/cm	≥2L/min	<0.01CFU/mL	<30ppb	-	-	-	-
DUO-i III 30	30L/hr	<5µS/cm	≥2L/min	<0.01CFU/mL	<30ppb	-	-	-	-
TYPE 1									
DUO-i III.I (ALL)	-	18.2MΩ-cm	≥2L/min	<0.01CFU/mL	≤5ppb	<0.001EU/mL	<1pg/mL	<1pg/mL	<0.15µg/mL

* With LWFS32302 final filter *** With TCO04 final filter
 ** With LWFS32303 final filter **** With feed water TOC less than 2ppm

Want to view the system Specifications?



SCAN ME



MODEL	MAKE-UP FLOW RATE (@15°C)	WATER QUALITY (@25°C)	DISPENSE FLOW RATE	BACTERIA*	TOC****	ENDOTOXINS**	RNASE***	DNASE***	PROTEASE***
TYPE 2									
DUO-i II.I 5	5L/hr	>5MΩ-cm	≥2L/min	<0.01CFU/ml	<30ppb	-	-	-	-
DUO-i II.I 10	10L/hr	>5MΩ-cm	≥2L/min	<0.01CFU/ml	<30ppb	-	-	-	-
DUO-i II.I 20	20L/hr	>5MΩ-cm	≥2L/min	<0.01CFU/ml	<30ppb	-	-	-	-
DUO-i II.I 30	30L/hr	>5MΩ-cm	≥2L/min	<0.01CFU/ml	<30ppb	-	-	-	-
TYPE 1									
DUO-i II.I (ALL)	-	18.2MΩ-cm	≥2L/min	<0.01CFU/ml	<5ppb	<0.001EU/mL	<1pg/mL	<1pg/mL	<0.15µg/mL

* With LWFS32302 final filter *** With TCO04 final filter
 ** With LWFS32303 final filter **** With feed water TOC less than 2ppm

Want to view the system Specifications?



SCAN ME



Alto™ I

Ultrapure,
Ultra-flexible



Ultrapure Water

- Type 1 water up to 2L/min
- Option of integrated and remote dispensers (up to two)
- Intuitive, icon-based, interactive user interface with touchscreen
- Mount on-bench, under-bench or on the wall
- Continuous TOC monitoring
- Low Endotoxin, RNase, DNase and Protease option available
- Volumetric and drop by drop dispensing

Alto™-i

Ultra-Intelligent,
Ultra-Informative



Ultrapure Water

- Type 1 water up to 2L/min
- Specific cartridges for your critical applications
- Data capture with printable option
- Cartridge traceability with data tag
- Interactive 7" touch screen
- Flexible dispensing options
- Drop by drop dispensing

MODEL	DISPENSE WATER QUALITY (@25°C)	DISPENSE FLOW RATE	BACTERIA	TOC	ENDOTOXINS***	RNASE***	DNASE***	PROTEASE***	FEED WATER PRESSURE
ALTO I	18.2MΩ-cm	≥2L/min	<0.01CFU/ml	≤5ppb	<0.001EU/ml	<1pg/mL	<5pg/mL	<0.15µg/mL	1 - 6 bar
ALTO I-T	18.2MΩ-cm	≥2L/min	<0.01CFU/ml	≤5ppb	<0.001EU/ml	<1pg/mL	<5pg/mL	<0.15µg/mL	0.1 bar

*** Using correct final filter TC004

MODEL	DISPENSE WATER QUALITY (@25°C)	DISPENSE FLOW RATE*	PARTICLES (>0.2µM)*	BACTERIA	TOC****	ENDOTOXINS**	RNASE***	DNASE***	PROTEASE***
ALTO-i I	18.2MΩ-cm	≥2L/min	<1/ml	<0.01CFU/ml	≤5ppb	<0.001EU/mL	<1pg/mL	<5pg/mL	<0.15µg/mL

* With LWFS32302 final filter

** With LWFS32303 final filter

*** With TC004 final filter

**** With feed water TOC less than 50ppb

Want to view the system Specifications?



SCAN ME

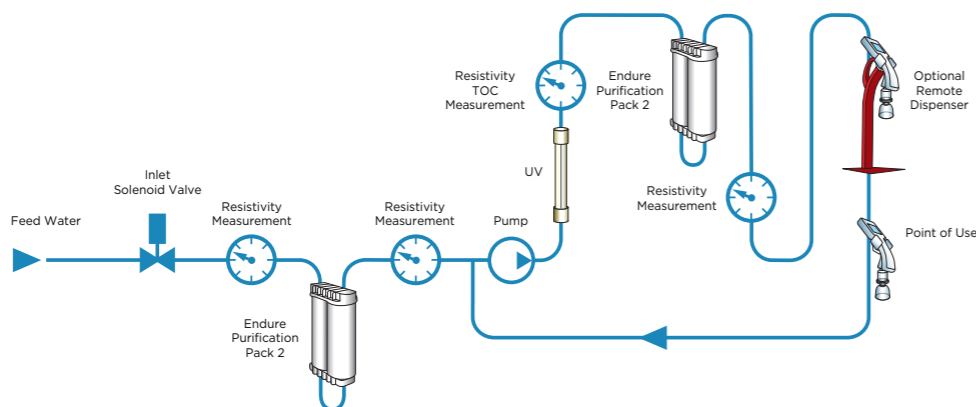

Want to view the system Specifications?



SCAN ME

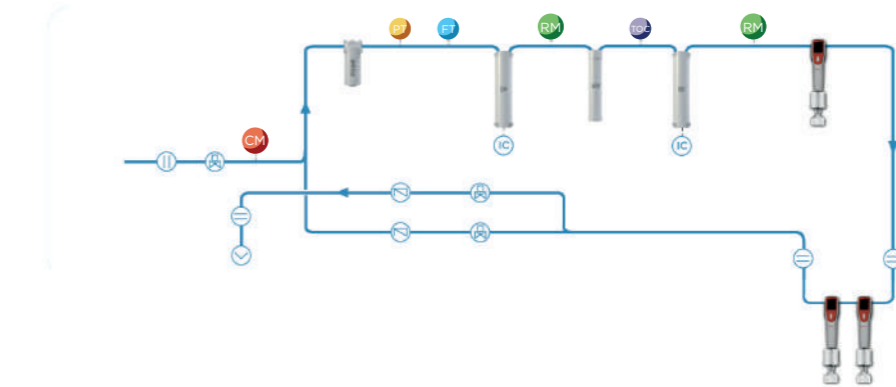

- Flow transmitter
- Pressure transmitter
- Resistivity transmitter
- Level sensor
- TOC Indicator
- Conductivity transmitter
- Solenoid valve
- Hand valve
- Intelligent chip
- Check valve
- Drain
- Connector



Storage Reservoirs

Reservoir Specifications

- Smooth, crevice-free interior, fully drainable
- Made from high quality polyethylene
- Connection to feed a laboratory dishwasher
- Optional UV light kit available
- Optional distribution pump on the 100L tank*



RESERVOIR	UNIT DIMENSIONS (mm)
100L TANK	810 (H) x 480 (W) x 360 (D)
60L TANK	495 (H) x 480 (W) x 330 (D)
30L TANK	495 (H) x 450 (W) x 230 (D)

* Applicable to Non i-Series systems only



RESERVOIR	UNIT DIMENSIONS (mm)	DRY WEIGHT (kg)
35L	600 (H) x 390 (W) x 384 (D)	5
70L	938 (H) x 390 (W) x 384 (D)	7
105L	1200 (H) x 390 (W) x 384 (D)	9

** Supplied with Puro-i III, Duo-i II.I and Duo-i III.I models only.

Accessories

Remote Dispensers

UNIT DIMENSIONS (mm)	DRY WEIGHT (kg)
845 (H) x 280 (W) x 300 (D)	6

* Applies to all i-Series models

UNIT DIMENSIONS (mm)	DRY WEIGHT (kg)
640 (H) x 250 (W) x 255 (D)	3

* Applies to Alto I and Duo II.I



i-Series Pre-treatment Module

UNIT DIMENSIONS (mm)	DRY WEIGHT (kg)
463 (H) x 220 (W) x 380 (D)	7

* Applies to Puro-i III, Duo-i III.I and Duo-i II.I



Consumables

We manufacture and supply consumables for all of our Laboratory Water Systems:

- Pre-treatment cartridges
- RO cartridges
- DI cartridges
- Point of use filters
- Tank vent filters



Sustainability and Green Innovations.

Passing the benefits on to you

 **Our RO water systems recover a percentage of water processed through the RO membranes.**

Due to the innovative configuration of the RO membrane and boost pump, when the final conductivity measurement is taken, any permeate water not meeting the required set point is recirculated back through the RO membrane rather than being flushed to drain. This process greatly improves the quality of the water and minimises water wastage.

 **Low Energy Consumption.**

Avidity Science laboratory water systems use less electricity, when in standby. This helps to preserve natural resources, reduce pollution and save money.

 **Energy Saving Mode.**

Avidity Science water systems automatically switch to energy saving mode after a period of inactivity. This reduces running costs and creates a quieter working environment.

 **Twin pass RO technology on *i-Series* models.**

This technology is able to process incoming feed water of up to 2000µS/cm, which will provide consumers with high quality water of 5µS/cm and a 99% ion rejection. This in turn improves life expectancy on DI cartridges, therefore reducing the frequency of change and environmental impact. Less waste.

 **Anti-vibration and dampening technology for non *i-Series* models.**

Using a unique dampening method, we have reduced pump noise and increased component life expectancy with less need for replacing critical parts.

 **Our Reservoirs and Purification Packs are manufactured from recyclable materials.**

All of our reservoirs are smooth and crevice-free, which makes them easier to sanitise and less likely to cultivate microbial growth.

A Global Presence.

We are where you are, speaking your language



Avidity Science, Ltd.

Unit D4 Drakes Park, Long Crendon Industrial Estate, Bucks. HP18 9BA UK
T: +44 (0)1844 201142
E: EMEA.Info@avidityscience.com
www.AvidityScience.com/en_gb

Avidity Science, LLC.

819 Bakke Avenue Waterford, Wisconsin 53185 USA
T: +1 262-534-5181
E: US.Info@avidityscience.com
www.AvidityScience.com

Avidity Science, SAS.

250 bis boulevard Saint Germain, 75007 Paris. France
T: +33 1 87 65 09 95
E: France@avidityscience.com
www.AvidityScience.com

Avidity Science (Zhejiang) Co., Ltd.

Bld F, No. 1332, WanGuo Road, EDZ, Jiaxing, Zhejiang, China. 341001
T: +86 (0)573 8282 8199
E: CH.Info@avidityscience.com
www.AvidityScience.cn

Avidity Science, K.K.

Izumi Akasaka Building 6th Floor, 2-22-24 Akasaka Minato-ku, Tokyo 107-0052
T: +81 (0)3 6277 8440
E: JP.Info@avidityscience.com
www.AvidityScience.jp

Avidity Science has offices and distributors worldwide. Contact us for our full partner listing.



LABORATORY WATER PORTFOLIO
LABORATORY WATER WITH CONFIDENCE

Avidity Science

Waterford, USA | Thame, UK |
Paris, France | Tokyo, Japan | Jiaxing, China

Contact@AvidityScience.com

www.AvidityScience.com/Global

