

---

No soft touch – only automated systems can boost productivity and quality when lapping/polishing fragile GaAs wafers

---

Author: Mark Kennedy

---

## Overview

The processing of GaAs (gallium arsenide) wafers differs from silicon carbide (SiC) in that the crystal is softer and more fragile. As a consequence, great consideration of the manufacturing process is required if both optimum productivity and quality are to be achieved. This white paper examines the latest automated technology for the processing of GaAs wafers and, through substantiated test results, demonstrates the impressive benefits on offer to wafer production facilities the world over.

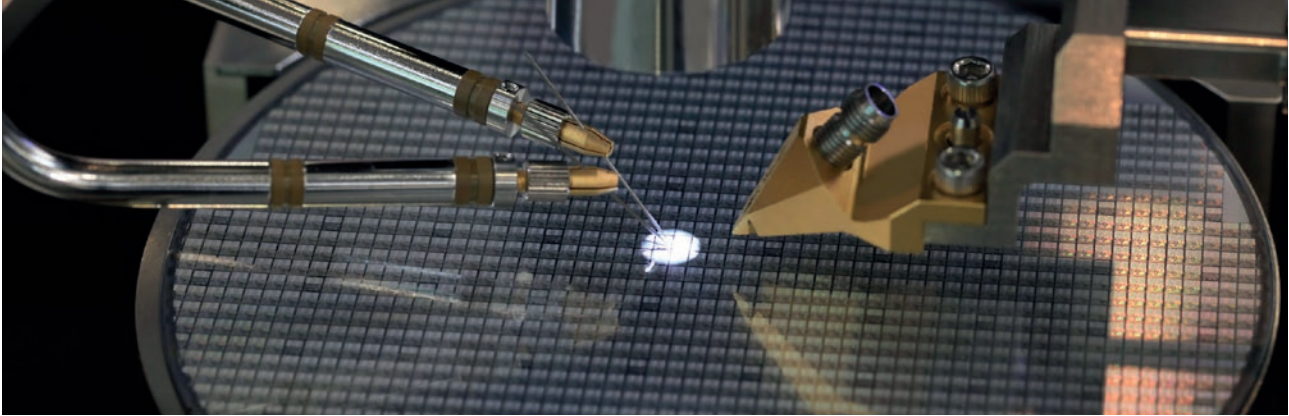

---

## GaAs wafer advantages

GaAs wafers exhibit certain electronic properties that are superior to silicon (Si). For instance, higher saturated electron velocity and higher electron mobility allow GaAs transistors to function at high frequencies. GaAs devices are also relatively insensitive to overheating owing to their wider energy bandgap, and tend to create less noise in electronic circuits. This is a result of higher carrier mobilities and lower resistive device parasitics.

Another advantage of GaAs is that it has a direct bandgap, which means that it can be used to absorb and emit light efficiently, unlike Si, which has an indirect bandgap and so is relatively poor at emitting light.

Because of its wide bandgap, pure GaAs is highly resistive. Combined with a high dielectric constant, this property makes it a very good substrate for integrated circuits and provides natural isolation between devices and circuits.

---

## GaAs wafer applications

Semi-insulating and semiconducting GaAs wafers are popular in high frequency and optoelectronic applications. For instance, in wireless communications, GaAs wafers are used for state of the art pHEMT (pseudomorphic high electron mobility transistor), HBT (heterojunction bipolar transistor) and MHEMT (metal semiconductor field effect transistors) device production.

GaAs-based semiconductors dominate wireless and high speed applications such as power amplifiers and switches for cellular phones, smart and feature phones,

WLAN-enabled devices and the infrastructure supporting these capabilities. The devices are also used for wireless broadband and Wi-Fi functionalities in PCs, notebooks and tablets, as well as for cable TV, direct broadcast satellite, telecoms, datacoms, social media, cloud and other modern technologies.

Due to the intrinsic nature of the bandgap of GaAs, these wafers are also used extensively in numerous optoelectronic devices including LEDs, lasers and solar cells.

---

## The manufacturing process

All wafers undergo several common stages during manufacture, including slicing the wafer from the crystal, preparing the surface prior to fabrication and subsequent thinning of the device through the deployment of lapping and polishing techniques.

After slicing, wafers are lapped to remove the surface damaged introduced by the cutting process. Typically this is performed using a lapping process to improve the flatness and micro-roughness of the wafers.

CMP (chemical mechanical polishing) is required to remove the material damaged in the lapping stage resulting in a highly polished surface with excellent flatness and surface roughness. This stage can often

be the final step in the manufacturing GaAs wafers. This process allows the attainment of super-flat, mirror-like surfaces with a remaining surface roughness close to an atomic scale. Typically, CMP is achieved using a rotary motion of a chemically modified abrasive slurry between the wafer and a polishing pad.

CP (Chemical Polishing / Etching) is an optional stage in the manufacture of GaAs wafers. The CP is required to remove material and residual subsurface damage created by the CMP process. This process allows the attainment of super-flat, mirror-like surfaces with a surface roughness at an atomic scale. Typically chemical polishing is achieved using a customized chemical etchant and polishing pad combination.

---

## GaAs wafer requirements

As a result of the extensive and demanding applications for GaAs wafers, there are strict industry requirements for flatness, which typically needs to be within  $\pm 2 \mu\text{m}$  and is determined by means of interferometry measuring equipment using a focal plane on the front surface as a reference.

Another vital parameter that must be controlled is TTV (total thickness variation) – the difference between the maximum and minimum thickness values of a wafer. Typically this should be within  $1 \mu\text{m}$  per 25 mm for GaAs wafers.

In all cases, a fundamental understanding of the manufacturing process is required to ensure a quality outcome. Different types of slurries and pads, along with plate speed and jig load can all impact the resulting surface.

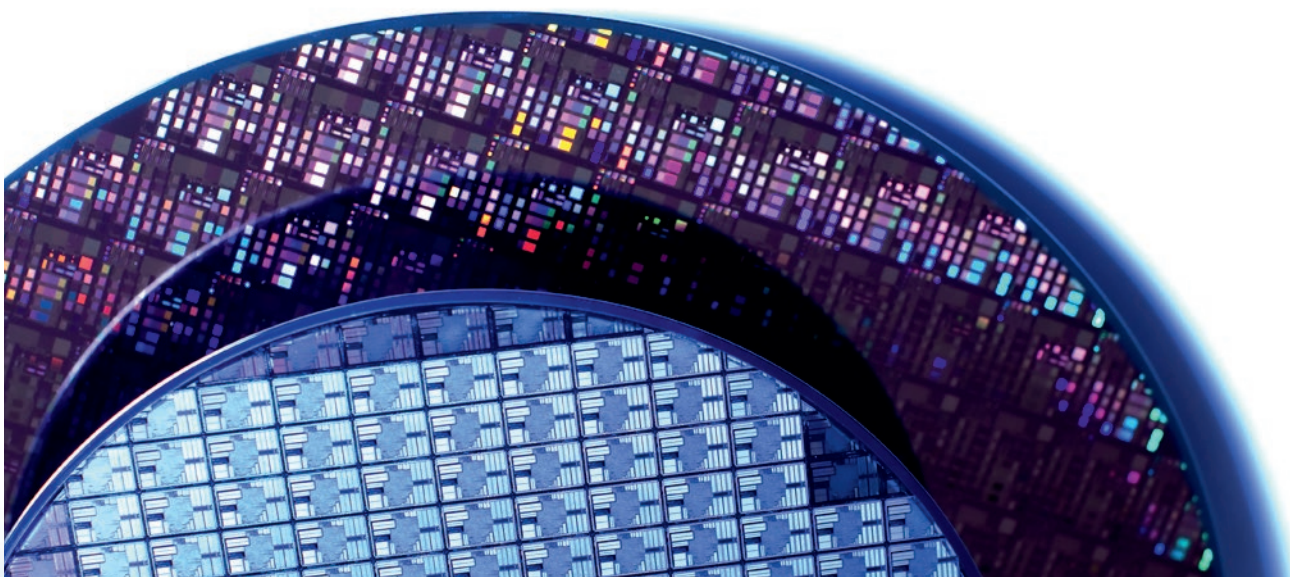

## Fundamental differences

When processing GaAs wafers, control of the lapping process/plate shape is paramount because the crystal is softer and more fragile than SiC, for example. In short, the lapping plate must be controlled and maintained at a specific shape depending on the diameter of the wafer.

The shape of the lapping plate deployed has a direct influence on the wafer shape before it enters the polishing stage, where the edge will naturally polish faster than the centre. During lapping, the ultimate aim is to manipulate the wafer shape to an extent that after polishing the wafer is within the flatness specification.



## Optimum manufacturing solutions

Although manual wafer lapping/polishing tools can meet general manufacturing requirements, because the plate shape has to be monitored and controlled manually, around 30-60 minutes of conditioning is required for every wafer cycle. In an industry that demands high productivity, this is clearly unacceptable. Unfortunately, the long cycle time cannot be avoided as the glass plate can change shape by around 15  $\mu\text{m}$  per hour using Lapping Slurry 1 if not controlled correctly.

The only alternative, therefore, is to seek out a solution that can take care of this function automatically. Tools such as the Akribis-air from Logitech are able to offer in-situ plate flatness control using an integrated monitor that tracks plate flatness during processing. Software then makes the necessary arm position adjustment to maintain or change plate flatness accordingly until the target shape is attained. Importantly, the control and maintenance of the plate shape does not require downtime for the plate conditioning cycle, as is the case with manual tools.

## Plate flatness monitoring and control

The plate flatness monitor on the Akribis-air comprises two diamond rings, one on a flexible diaphragm with an LVDT (linear variable differential transformer) monitoring the fluctuations of one ring relative to the other.

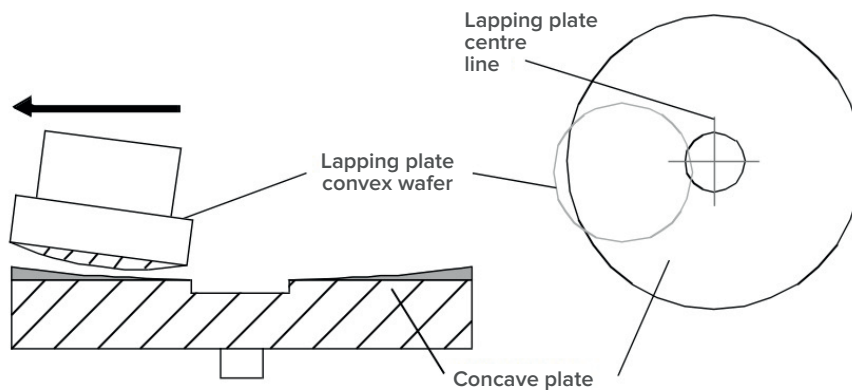

Correcting a concave plate

Plate shape is controlled through software adjustment of the arm to an outer position to increase material removal at the outer edge of the plate, thus reducing concavity. This is required if the plate is more concave relative to the selected target.

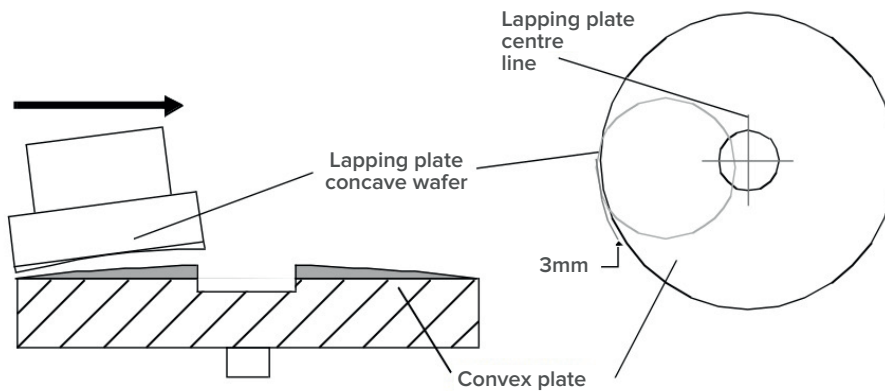

Correcting a convex plate

To reduce convexity, software adjustment of the arm to an inner position increases material removal at the inner edge of the plate. Similarly, this is required if the plate is more convex relative to the selected target.

---

## Dynamic lapping

To reduce the sub-surface damage and improve the surface roughness when manufacturing GaAs wafers, a dynamic lapping process can be performed.

Dynamic lapping is when the load starts off high at, say 4x and, as the thickness of the GaAs wafer is reduced, the load is also reduced in phases to 3x, then 2x, and finally x before achieving the final lapping target thickness.

The lighter load during lapping will produce a better surface roughness and reduced sub-surface damage at the end of the lap and therefore reduce the polishing time required to achieve the target surface roughness, which is typically  $Ra < 3$  nm. The Akribis-air can perform this in one continuous operation, unlike existing Logitech or competitor solutions.

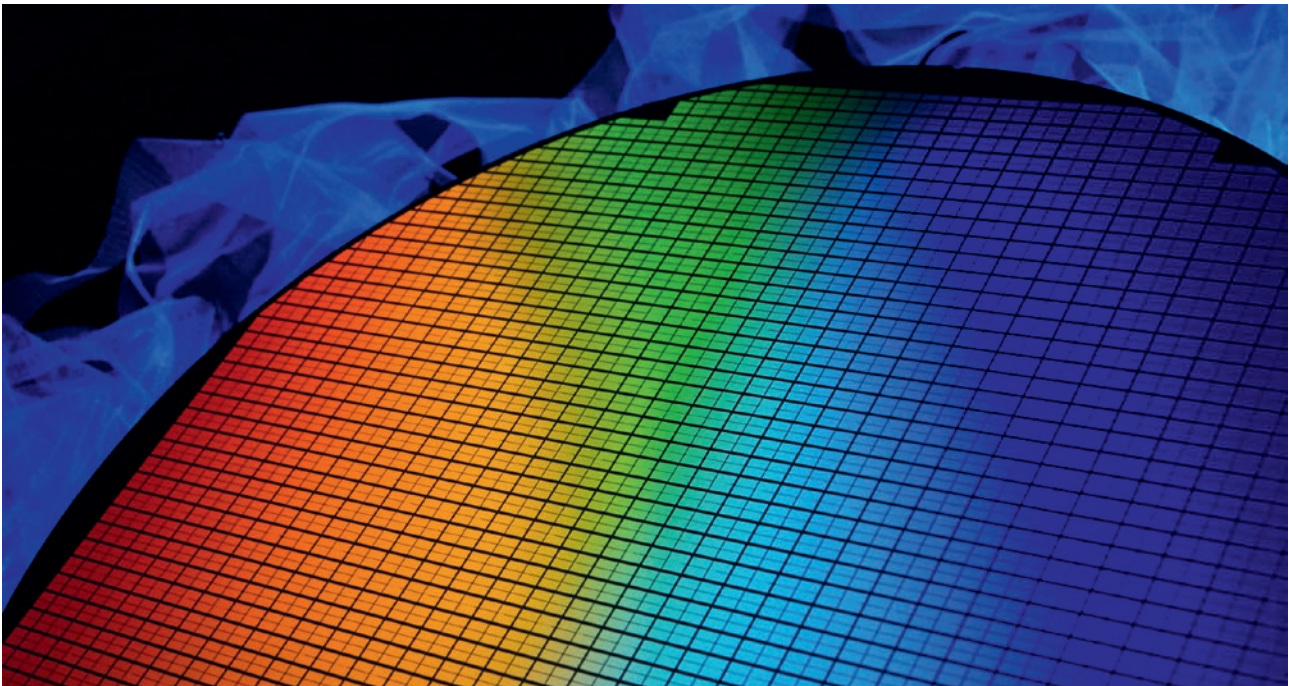

---

## The results

Logitech has undertaken extensive tests on the lapping and polishing of GaAs wafers of sizes ranging from 2” through to 6” outside diameter. The trials show the material removal rate (MMR) that can be achieved when lapping and polishing GaAs wafers with Akribis-air while maintaining the required flatness and TTV values.

With a constant plate speed for the lapping tests, six runs were performed for each of the three lapping slurries used. Two lapping runs were completed at a jig load of 3x, with a further two runs at 2x, and two more at x.

**2" Diameter Wafer - GaAs Lapping Rate with Lapping Slurry 1 / Lapping Slurry 2 / Lapping Slurry 3 Vs. Jig Load**

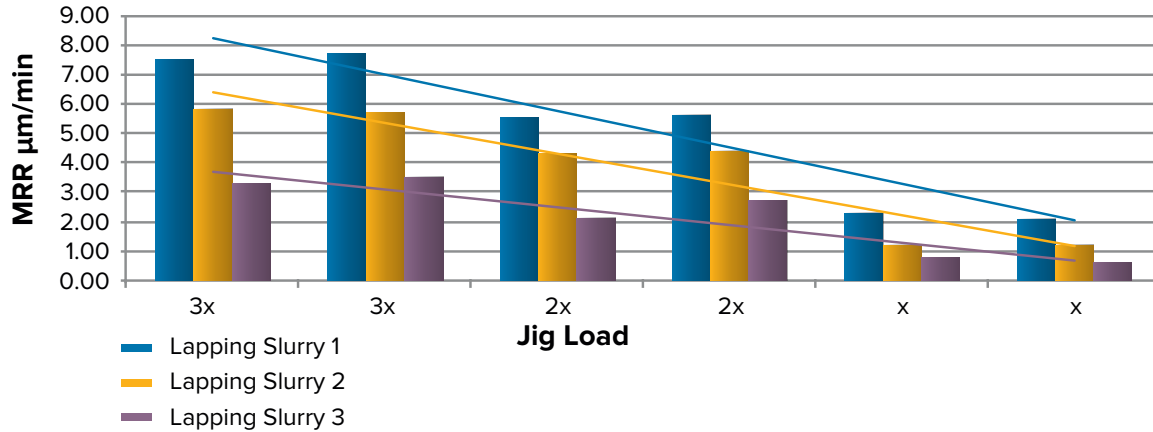

Run Number	Lapping Slurry	Jig Load	Plate Speed	Plate Shape	Wafer OD	Material Removal Rate (µm/min)
1	1	3x	15	T	2"	7.50
2	1	3x	15	T	2"	7.70
3	1	2x	15	T	2"	5.50
4	1	2x	15	T	2"	5.60
5	1	x	15	T	2"	2.30
6	1	x	15	T	2"	2.10
1	2	3x	15	T	2"	5.80
2	2	3x	15	T	2"	5.70
3	2	2x	15	T	2"	4.30
4	2	2x	15	T	2"	4.40
5	2	x	15	T	2"	1.20
6	2	x	15	T	2"	1.20
1	3	3x	15	T	2"	3.30
2	3	3x	15	T	2"	3.50
3	3	2x	15	T	2"	2.14
4	3	2x	15	T	2"	2.72
5	3	x	15	T	2"	0.80
6	3	x	15	T	2"	0.60

For the 2" diameter wafer, MRR was as high as 7.70 µm/min when lapping with Lapping Slurry 1 at 3x jig load, 5.60 µm/min at 2x jig load, and 2.30 µm/min at x.

Switching to Lapping Slurry 2 saw MRR reach 5.80 µm/min at 3x jig load, 4.40 µm/min at 2x jig load, and 1.2 µm/min at x. Finally, using Lapping Slurry 3 yielded MRR of 3.50 µm/min at 3x jig load, 2.72 µm/min at 2x jig load, and 0.8 µm/min at x.

**3" Diameter Wafer - GaAs Lapping Rate with Lapping Slurry 1 / Lapping Slurry 2 / Lapping Slurry 3 Vs. Jig Load**

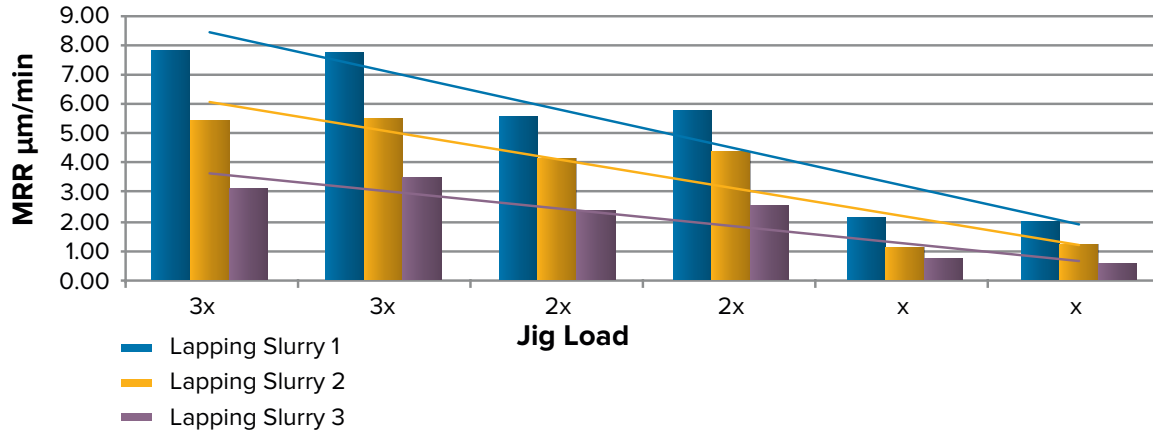

Run Number	Lapping Slurry	Jig Load	Plate Speed	Plate Shape	Wafer OD	Material Removal Rate (µm/min)
1	1	3x	15	T-2	3"	7.80
2	1	3x	15	T-2	3"	7.70
3	1	2x	15	T-2	3"	5.53
4	1	2x	15	T-2	3"	5.72
5	1	x	15	T-2	3"	2.10
6	1	x	15	T-2	3"	2.00
1	2	3x	15	T-2	3"	5.40
2	2	3x	15	T-2	3"	5.50
3	2	2x	15	T-2	3"	4.10
4	2	2x	15	T-2	3"	4.35
5	2	x	15	T-2	3"	1.10
6	2	x	15	T-2	3"	1.20
1	3	3x	15	T-2	3"	3.10
2	3	3x	15	T-2	3"	3.50
3	3	2x	15	T-2	3"	2.34
4	3	2x	15	T-2	3"	2.53
5	3	x	15	T-2	3"	0.75
6	3	x	15	T-2	3"	0.55

When lapping the 3" diameter wafer, MRR reached 7.80 µm/min with Lapping Slurry 1 at 3x jig load, 5.72 µm/min at 2x jig load, and 2.10 µm/min at x.

Changing to Lapping Slurry 2 witnessed MRR of 5.50 µm/min at 3x jig load, 4.35 µm/min at 2x jig load, and 1.2 µm/min at x. Then, using Lapping Slurry 3 saw MRR of 3.50 µm/min at 3x jig load, 2.53 µm/min at 2x jig load, and 0.75 µm/min at x.



### 4" Diameter Wafer - GaAs Lapping Rate with Lapping Slurry 1 / Lapping Slurry 2 / Lapping Slurry 3 Vs. Jig Load

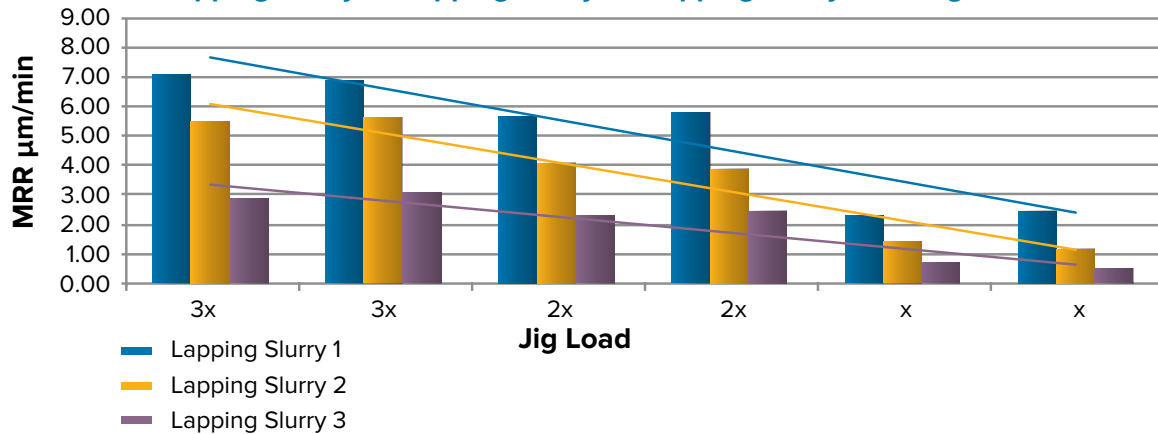

Run Number	Lapping Slurry	Jig Load	Plate Speed	Plate Shape	Wafer OD	Material Removal Rate (µm/min)
1	1	3x	15	T-4	4"	7.10
2	1	3x	15	T-4	4"	6.90
3	1	2x	15	T-4	4"	5.70
4	1	2x	15	T-4	4"	5.80
5	1	x	15	T-4	4"	2.30
6	1	x	15	T-4	4"	2.45
1	2	3x	15	T-4	4"	5.50
2	2	3x	15	T-4	4"	5.65
3	2	2x	15	T-4	4"	4.10
4	2	2x	15	T-4	4"	3.90
5	2	x	15	T-4	4"	1.40
6	2	x	15	T-4	4"	1.15
1	3	3x	15	T-4	4"	2.90
2	3	3x	15	T-4	4"	3.10
3	3	2x	15	T-4	4"	2.30
4	3	2x	15	T-4	4"	2.45
5	3	x	15	T-4	4"	0.70
6	3	x	15	T-4	4"	0.50

For the 4" diameter wafer, MRR was as high as 7.10 µm/min when lapping with Lapping Slurry 1 at 3x jig load, 5.80 µm/min at 2x jig load, and 2.45 µm/min at x.

Switching to Lapping Slurry 2 saw MRR reach 5.65 µm/min at 3x jig load, 4.10 µm/min at 2x jig load, and 1.4 µm/min at x. Finally, using Lapping Slurry 3 yielded MRR of 3.10 µm/min at 3x jig load, 2.45 µm/min at 2x jig load, and 0.7 µm/min at x.

### 6" Diameter Wafer - GaAs Lapping Rate with Lapping Slurry 1 / Lapping Slurry 2 / Lapping Slurry 3 Vs. Jig Load

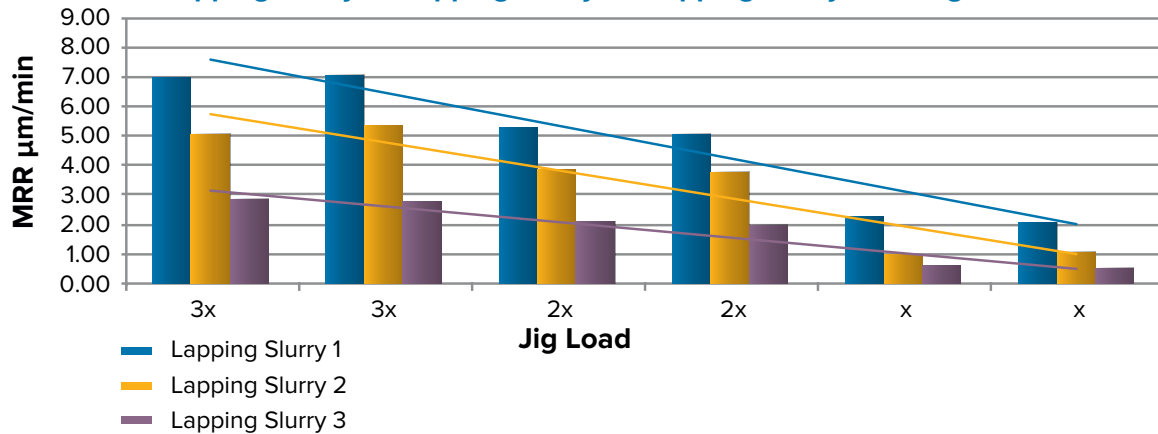

Run Number	Lapping Slurry	Jig Load	Plate Speed	Plate Shape	Wafer OD	Material Removal Rate (μm/min)
1	1	3x	25	T-4	6"	7.02
2	1	3x	25	T-4	6"	7.10
3	1	2x	25	T-4	6"	5.30
4	1	2x	25	T-4	6"	5.10
5	1	x	25	T-4	6"	2.30
6	1	x	25	T-4	6"	2.10
1	2	3x	25	T-4	6"	5.10
2	2	3x	25	T-4	6"	5.40
3	2	2x	25	T-4	6"	3.90
4	2	2x	25	T-4	6"	3.80
5	2	x	25	T-4	6"	1.00
6	2	x	25	T-4	6"	1.09
1	3	3x	25	T-4	6"	2.90
2	3	3x	25	T-4	6"	2.81
3	3	2x	25	T-4	6"	2.14
4	3	2x	25	T-4	6"	2.00
5	3	x	25	T-4	6"	0.61
6	3	x	25	T-4	6"	0.52

When lapping the 6" diameter wafer, MRR reached 7.10 μm/min with Lapping Slurry 1 at 3x jig load, 5.30 μm/min at 2x jig load, and 2.30 μm/min at x.

Changing to Lapping Slurry 2 witnessed MRR of 5.40 μm/min at 3x jig load, 3.90 μm/min at 2x jig load, and 1.09 μm/min at x. Then, using Lapping Slurry 3 saw MRR of 2.90 μm/min at 3x jig load, 2.14 μm/min at 2x jig load, and 0.61 μm/min at x.

With regards to polishing, again six runs were completed for each of the four wafer diameters, with Logitech Proprietary Polishing Slurry abrasive and a constant plate speed of 70 rpm deployed in all test runs. Two polishing runs were completed at a jig load of 4x, with a further two runs at 3x, and two more at 2x.

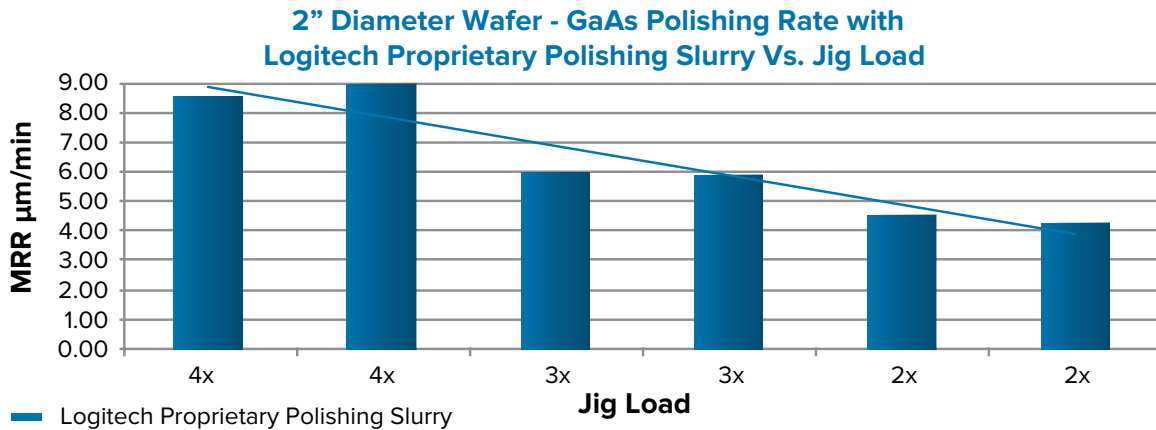

Run Number	Lapping Slurry	Jig Load	Plate Speed	Plate Shape	Wafer OD	Material Removal Rate (µm/min)
1	Logitech Proprietary Polishing Slurry	4x	70	0	2"	8.570
2	Logitech Proprietary Polishing Slurry	4x	70	0	2"	8.970
3	Logitech Proprietary Polishing Slurry	3x	70	0	2"	6.010
4	Logitech Proprietary Polishing Slurry	3x	70	0	2"	5.930
5	Logitech Proprietary Polishing Slurry	2x	70	0	2"	4.540
6	Logitech Proprietary Polishing Slurry	2x	70	0	2"	4.300

For the 2" diameter wafer, MRR was as high as 8.97 µm/min when polishing at 4x jig load, 6.01 µm/min at 3x, and 4.54 µm/min at 2x jig load.

### 3" Diameter Wafer - GaAs Polishing Rate with Logitech Proprietary Polishing Slurry Vs. Jig Load

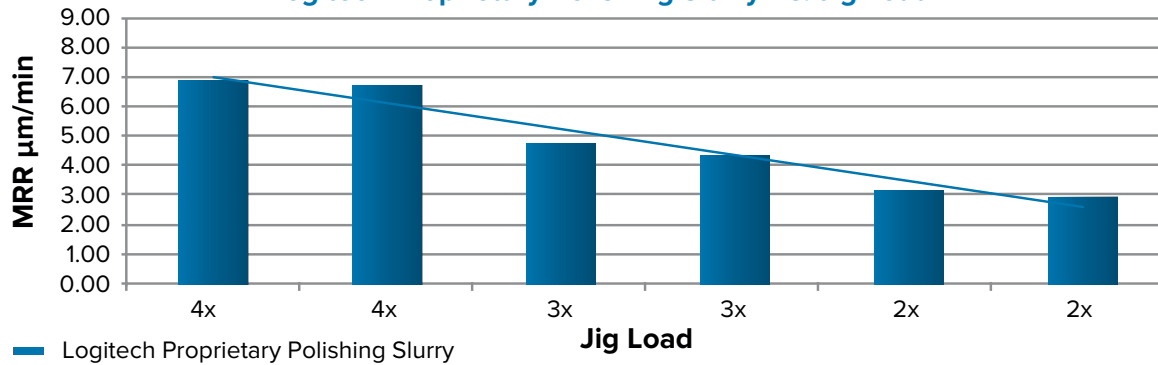

Run Number	Lapping Slurry	Jig Load	Plate Speed	Plate Shape	Wafer OD	Material Removal Rate (μm/min)
1	Logitech Proprietary Polishing Slurry	4x	70	0	3"	6.850
2	Logitech Proprietary Polishing Slurry	4x	70	0	3"	6.640
3	Logitech Proprietary Polishing Slurry	3x	70	0	3"	4.720
4	Logitech Proprietary Polishing Slurry	3x	70	0	3"	4.330
5	Logitech Proprietary Polishing Slurry	2x	70	0	3"	3.160
6	Logitech Proprietary Polishing Slurry	2x	70	0	3"	2.950

When polishing the 3" diameter wafer, MRR reached 6.85 μm/min at 4x jig load, 4.72 μm/min at 3x, and 3.16 μm/min at 2x jig load.

### 4" Diameter Wafer - GaAs Polishing Rate with Logitech Proprietary Polishing Slurry Vs. Jig Load

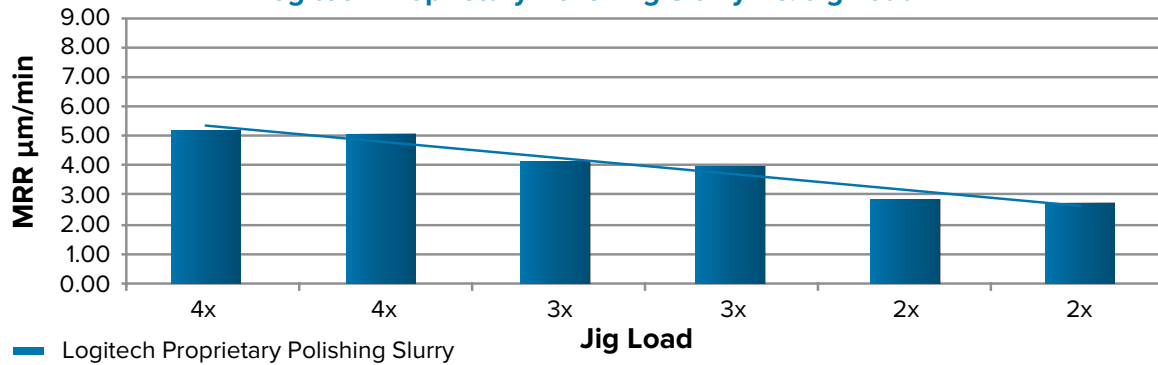

Run Number	Lapping Slurry	Jig Load	Plate Speed	Plate Shape	Wafer OD	Material Removal Rate (μm/min)
1	Logitech Proprietary Polishing Slurry	4x	70	0	4"	5.130
2	Logitech Proprietary Polishing Slurry	4x	70	0	4"	5.01
3	Logitech Proprietary Polishing Slurry	3x	70	0	4"	4.10
4	Logitech Proprietary Polishing Slurry	3x	70	0	4"	3.92
5	Logitech Proprietary Polishing Slurry	2x	70	0	4"	2.820
6	Logitech Proprietary Polishing Slurry	2x	70	0	4"	2.710

For the 4" diameter wafer, MRR was as high as 5.13 μm/min when polishing at 4x jig load, 4.10 μm/min at 3x, and 2.82 μm/min at 2x jig load.

### 6" Diameter Wafer - GaAs Polishing Rate with Logitech Proprietary Polishing Slurry Vs. Jig Load

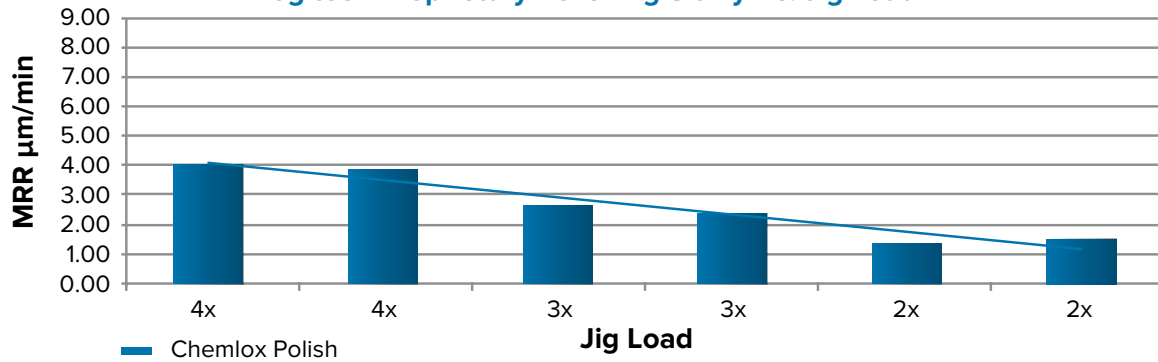

Run Number	Lapping Slurry	Jig Load	Plate Speed	Plate Shape	Wafer OD	Material Removal Rate (μm/min)
1	Logitech Proprietary Polishing Slurry	4x	70	0	6"	3.98
2	Logitech Proprietary Polishing Slurry	4x	70	0	6"	3.81
3	Logitech Proprietary Polishing Slurry	3x	70	0	6"	2.62
4	Logitech Proprietary Polishing Slurry	3x	70	0	6"	2.34
5	Logitech Proprietary Polishing Slurry	2x	70	0	6"	1.35
6	Logitech Proprietary Polishing Slurry	2x	70	0	6"	1.50

When polishing the 6" diameter wafer, MRR reached 3.98 μm/min at 4x jig load, 2.62 μm/min at 3x, and 1.50 μm/min at 2x jig load.

## Conclusion

GaAs wafer manufacturers demand greater productivity and process control in their search for more cost effective yet repeatable quality.

Evidence from extensive trials demonstrates that automated systems such as the Akribis-air can offer significant process improvements relating to GaAs wafer production, specifically with regard to automated plate shape control. Furthermore, dynamic lapping offers lower surface roughness while at the same time reducing the time required for subsequent polishing.

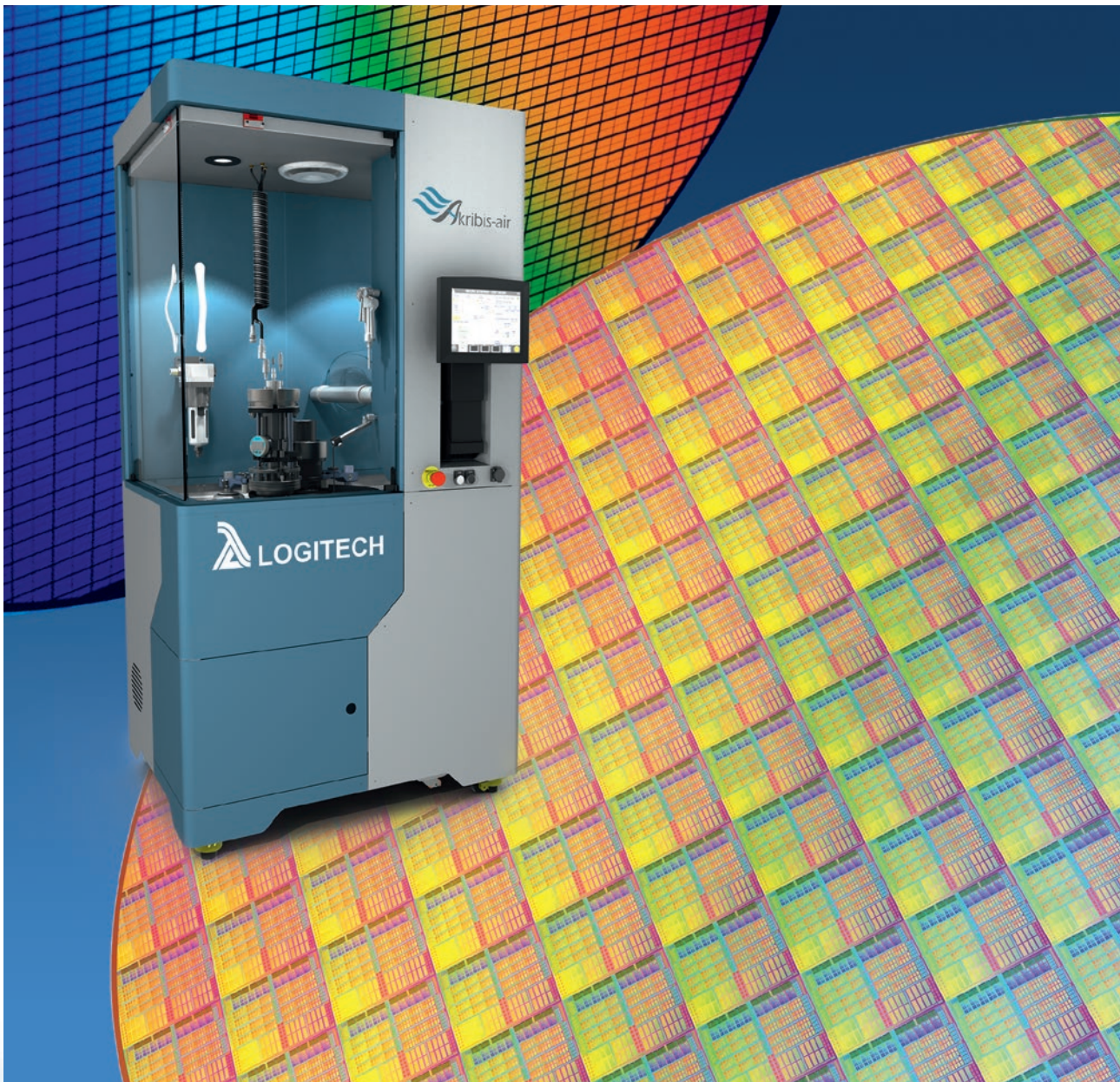



For further information please visit our website:

[www.logitech.uk.com](http://www.logitech.uk.com)